

**BAND GAP ENERGY OF SILICON AND
GERMANIUM DIODE**

PROJECT REPORT

Submitted by
ANGELA BENSELY
(AB20PHY028)

Under the guidance of
Dr. PRIYA PARVATHI AMEENA JOSE
Assistant Professor
Department of Physics,
St. Teresa's College (Autonomous), Ernakulam
Submitted to
Mahatma Gandhi University, Kottayam

*In the partial fulfilment of the requirements of award of
Bachelor degree of Science in Physics.*



ST. TERESA'S COLLEGE (AUTONOMOUS)
ERNAKULAM
2022-23

**BAND GAP ENERGY OF SILICON AND
GERMANIUM DIODE**

PROJECT REPORT

Submitted by
ANGELA BENSELY
(AB20PHY028)

Under the guidance of
Dr. PRIYA PARVATHI AMEENA JOSE
Assistant Professor
Department of Physics,
St. Teresa's College (Autonomous), Ernakulam
Submitted to
Mahatma Gandhi University, Kottayam

*In the partial fulfilment of the requirements of award of
Bachelor degree of Science in Physics.*



ST. TERESA'S COLLEGE (AUTONOMOUS)
ERNAKULAM
2022-23

ST. TERESA'S COLLEGE (AUTONOMOUS)
ERNAKULAM



CERTIFICATE

This is to certify that the project report entitled "**BAND GAP ENERGY OF SILICON AND GERMANIUM DIODE**" is an authentic work done by ANGELA BENSELY, St Teresa's College, Ernakulam, under my supervision at Department of Physics, St Teresa's college , Ernakulam, for the partial requirements for the award of Degree of Bachelor of Science in Physics during the academic year 2022-23. The work presented in this dissertation has not been submitted for any other degree in this or any other university.

Supervising Guide 
Dr. PRIYA PARVATHI AMEENA JOSE Assistant professor

Head of the Department 
Dr. PRIYA PARVATHI AMEENA JOSE Assistant professor

**ST. TERESA'S COLLEGE (AUTONOMOUS)
ERNAKULAM**



**B.Sc. PHYSICS
PROJECT REPORT**

Name : ANGELA BENSELY

Register number : AB20PHY028

Year of Work : 2022-2023

This is to certify that this project work entitled, '**BAND GAP ENERGY OF SILICON AND GERMANIUM DIODE**' is an authentic work done by ANGELA BENSELY.

Staff member in-charge Priya

Smt. Dr. Priya Parvathi Ameena Jose

Head of the Department Priya

Dr. Priya Parvathi Ameena Jose

Submitted for the university examination held at St. Teresa's College, Ernakulam.

DATE: 25-4-2023

EXAMINER: Nayy
24/04/23



Priya

DECLARATION

I, **ANGELA BENSELY**, final year B.Sc Physics student, Department of Physics, St. Teresa's College (Autonomous), Ernakulam, do hereby declare that the project work entitled "**BAND GAP ENERGY OF SILICON AND GERMANIUM DIODE**", has been originally carried out under the guidance and supervision of **Smt. Dr. PRIYA PARVATHI AMEENA JOSE**, Assistant Professor, Department Of Physics, St. Teresa's College (Autonomous), Ernakulam, in partial fulfilment for the award of the degree of Bachelor of Physics. I further declare that this project is not partially or wholly submitted for any other purpose and the data included in the project is collected from various sources and are true to be the best of my knowledge.

PLACE: ERNAKULAM

DATE : 25-4-2023

ANGELA BENSELY

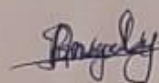

ACKNOWLEDGEMENT

First and foremost, I would like to thank God almighty for showering his blessing on me in this endeavour.

I wish to express my sincere gratitude to Dr. Priya Parvathi Ameena Jose, Department of Physics, St. Teresa's College (Autonomous), Ernakulam, for her guidance, timely help, expert advice, support and persistent encouragement given to me throughout the duration of my project work.

I express my deep sense of gratitude to the Department of Physics, St. Teresa's College (Autonomous), Ernakulam, for extending the facilities and co-operation required from time to time. I take this opportunity to thank once again Dr. Priya Parvathi Ameena Jose, Head of the Department of Physics for generous concern and support.

Last but not the least I express my thanks to all teaching and non-teaching staff of the department of Physics, for their kind co-operation.

CONTENTS

I.	Abstract	1
II.	Chapter 1	2
	1.1 Introduction	2
III.	Chapter 2	4
	2.1 Conductors, Semiconductors & Insulators	4
	2.2 Semiconductors	5
	2.3 Types of semiconductors	6
	2.4 n-type semiconductor and p-type semiconductor	8
	2.5 PN junction and its properties	12
	2.6 Forward biasing and Reverse biasing pf a p-n junction	13
	2.7 Effect of temperature on semiconductors	17
	2.8 Fermi level and Fermi energy	17
	2.9 Energy Band description of Semiconductors	19
IV.	Chapter 3	22
	3.1 Experimental set up and procedure	22
	3.2 Observation and Result Analysis	23
V.	Chapter 4	32
	4.1 Applications of Ge and Si	32
VI.	Reference	33

ABSTRACT

Semiconductors have wide applications and are of great importance in this era. Semiconductors are extensively used for the preparation of solid-state devices like the diode, transistor, etc. Germanium and Silicon are the most preferable semiconductor materials whose conductivity lie in between that of conductors and insulators. In the energy band diagram of semiconductors, the conduction band is almost empty and the valence band is almost completely filled and the forbidden gap between the two bands is very small that is about 1eV. For Germanium, the forbidden gap is 0.7eV and for Silicon, it is 1.1eV.

This project briefly describes an experiment to determine the band energy gap of silicon and germanium diodes. To determine the energy band gap of the semiconducting material, the variation of its conductance with temperature was studied and it was found that the measured band gap energy for Ge and Si is close to the standard values.

CHAPTER 1

1.1 Introduction

Materials are classified as conductors, insulators, or semiconductors according to their electric conductivity. The classifications can be understood in atomic terms. Electrons in an atom can have only certain well-defined energies, and, depending on their energies, the electrons are said to occupy particular energy levels. In a typical atom with many electrons, the lower energy levels are filled, each with the number of electrons allowed by a quantum mechanical rule known as the Pauli exclusion principle. Depending on the element, the highest energy level to have electrons may or may not be completely full. If two atoms of some element are brought close enough together so that they interact, the two-atom system has two closely spaced levels for each level of the single atom. If 10 atoms interact, the 10-atom system will have a cluster of 10 levels corresponding to each single level of an individual atom. In a solid, the number of atoms and hence the number of levels is extremely large; most of the higher energy levels overlap in a continuous fashion except for certain energies in which there are no levels at all. Energy regions with levels are called energy bands, and regions that have no levels are referred to as band gaps.

The highest energy band occupied by electrons is the valence band. In a conductor, the valence band is partially filled, and since there are numerous empty levels, the electrons are free to move under the influence of an electric field; thus, in a metal the valence band is also the conduction band. In an insulator, electrons completely fill the valence band; and the gap between it and the next band, which is the conduction band, is large. The electrons cannot move under the influence of an electric field unless they are given enough energy to cross the large energy gap to the conduction band. In a semiconductor, the gap to the conduction band is smaller than in an insulator. At room temperature, the valence band is almost completely filled. A few electrons are missing from the valence band because they have acquired enough thermal energy to cross the band gap to the conduction band; as a result, they can move under the influence of an external electric field. The “holes” left behind in the valence band are mobile charge carriers but behave like positive charge carriers.

For many materials, including metals, resistance to the flow of charge tends to increase with temperature. For example, an increase of 5° C (9° F) increases the resistivity of copper by 2 percent. In contrast, the resistivity of insulators and especially of semiconductors such as silicon and germanium decrease rapidly with temperature; the increased thermal energy causes

some of the electrons to populate levels in the conduction band where, influenced by an external electric field, they are free to move. The energy difference between the valence levels and the conduction band has a strong influence on the conductivity of these materials, with a smaller gap resulting in higher conduction at lower temperatures.

Semiconductors have broad applications due to their reliability, affordability and compactness. These find applications in optical sensors, optical sensors, light emitters including solid state lasers. With current ratings greater than 5,000 amperes and voltage ratings greater than 100,000 volts, they are capable of managing a wide range of current and voltage.

A diode is a semiconductor device with two terminals, typically allowing the flow of current in one direction only. They are used as rectifiers and voltage regulators. When exposed to light, semiconductors can create electron hole pairs, increasing the number of free carriers and thus the conductivity. Photodiodes are diodes designed to benefit from this phenomenon. There are light emitting diodes used in manufacturing, bulbs, signal lamps and displays. Infrared LEDs are used for optical fibre communication.

Transistor is a three terminal semiconductor device having two p-n junctions in either p-n-p configuration or n-p-n configuration. The field-effect transistor is a different kind of transistor that works on the concept that the presence of an electric field may change the conductivity of semiconductors. A semiconductor's conductivity may be altered by an electric field by increasing the number of electrons and holes present. The electric field may be applied by a reverse-biased p-n junction, and it forms a junction field-effect transistor (JFET) or by an electrode insulated from the bulk material by an oxide layer, and it forms a metal-oxide semiconductor field-effect transistor (MOSFET). All types of transistors can be used as building blocks of logic gates, which is useful for digital circuit design. In digital circuits such as microprocessors, transistors that act as switches (on-off); for example, in the case of the MOSFET, the voltage present at the gate determines whether the switch is on or off.

Solar cell is a semiconductor device that converts photons of solar light into electricity. It is also known as photovoltaic cell. It is widely used as a renewable source of energy. Domestic and industrial energy supply, traffic signs, emergency phones, water irrigation pumps, lightning for roadways, stream flow gauges make use of solar cells. They are also used in providing power supply to satellites.

Hence it can be concluded that a life without semiconductors is impossible. We can find semiconductors in almost all electrical equipment. Owing to their compactness, affordability and reliability semiconductors have a significant role in the field of technology.

CHAPTER 2

2.1 Conductors, Semiconductors & Insulators & Energy Bands

Based on the conduction of electricity, solids are classified into conductors, insulators and then there is also an intermediate class of semiconductors. This difference in the behaviour of solids based on their electrical conductivity can be explained in terms of their energy bands also.

Insulators: - Insulators are substances which do not allow the passage of electricity through them. In terms of energy band, the valence band is full while the conduction band is empty and the energy gap between the valence band and conduction band is very large (≈ 15 eV). That means, a very high electronic field is required for the valence electrons to cross over to the conduction band or else at room temperature the valence electrons of the insulators do not have enough energy to cross over to the conduction band. Therefore, the electrical conductivity of such materials is extremely small, and may be regarded as nil under normal conditions.

Conductors: - They are substances that easily allow the passage of electric current through them. A large number of free electrons are present in a conductor. As for energy bands, the valence and conduction bands overlap with each other. As a result, a slight potential difference across the conductor causes the free electrons to constitute electric current.

Semiconductors: - Semiconductors are substances whose electrical conductivity lies in between that of conductors and insulators. In terms of energy bands, the valence and conduction bands are separated by a very small energy gap. The valence band is almost filled, and the conduction band is almost empty. Therefore, comparatively smaller electric field is required to push the electrons from the valence band to the conduction band. Ge & Si are examples of two semiconductors.

Like an insulator as temperature rises, electrons from the valence band cross over to the conduction band and conductivity increases. Semiconductors have negative temperature coefficient of resistance.

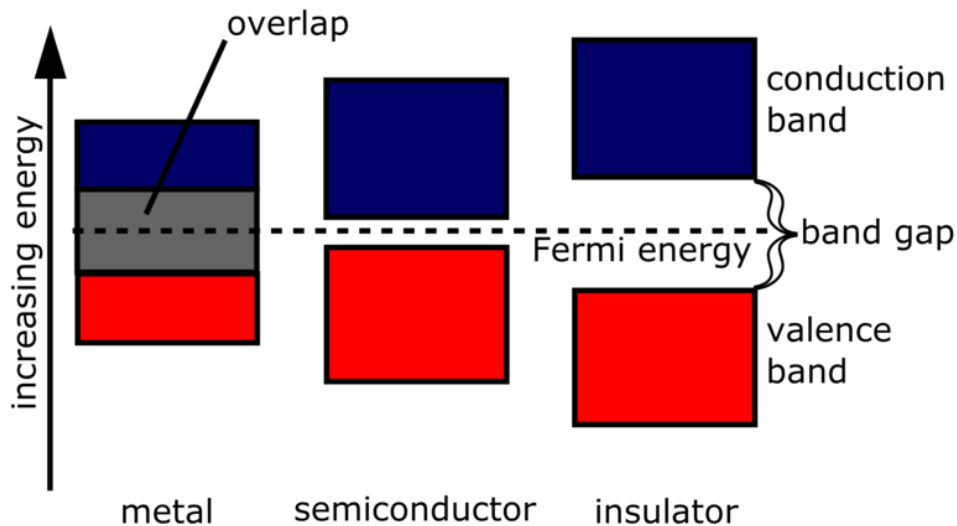

Fig 2.1 Energy band gap structure of conductors, semiconductors and insulators

2.2 Semiconductors

Semiconductor is a substance which has a resistivity in between that of a conductor and an insulator (resistivity: 10^{-4} to $0.5 \Omega\text{m}$)

SUBSTANCE	NATURE	RESISTIVITY
COPPER	GOOD CONDUCTOR	$1.7 \times 10^{-8} \Omega\text{m}$
GERMANIUM	SEMICONDUCTOR	$0.6 \Omega\text{m}$
GLASS	INSULATOR	$9 \times 10^{11} \Omega\text{m}$
NICHROME	RESISTANCE MATERIAL	$10^{-4} \Omega\text{m}$

Comparing the resistivities of the above materials it is evident that the resistivity of semiconductors lies in between that of a conductor and an insulator. It can also not be considered a resistance material. Nichrome, which is one of the highest resistance materials, has resistivity below that of germanium. This gave substances like germanium the name semiconductors. However, resistivity alone is not the factor that decides whether a substance is a semiconductor or not. For instance, it is possible to engineer an alloy whose resistivity falls within the range of semiconductors, but the alloy cannot be regarded as a semiconductor. They

have many peculiar properties which distinguish them from conductors, insulators and resistance material.

PROPERTIES OF SEMICONDUCTORS

- i. The resistivity is less than an insulator but more than a conductor.
- ii. They have negative temperature coefficient of resistance. i.e., the resistance of a semiconductor decreases with the increase in temperature and vice versa.
- iii. When a suitable metallic impurity (e.g., arsenic, gallium etc.) is added to a semiconductor, its current conducting properties change drastically.

There are many semiconductors available, but very few among them have practical applications in electronics. The two most frequently used metals are germanium (Ge) and silicon (Si). It is because the energy required to break their covalent bond is very small; about 0.72 eV for germanium and 1.1 eV for silicon. All semiconductors have crystalline structure.

2.3 Types of semiconductors

There are two types of semiconductors based on their purity, namely intrinsic and extrinsic semiconductors.

Intrinsic Semiconductor

A semiconductor in extremely pure form is known as intrinsic semiconductor. Acts as an insulator at 0 kelvin. When temperature rises, the covalent bond breaks and electrons move out of the covalent bonds and produce holes. Here the number of holes is equal to the number of free electrons, $n_i = p_i$.

Extrinsic semiconductor

The intrinsic semiconductor has very low current conduction at room temperature. Therefore, in order to increase their conduction capacity, a small amount of suitable impurity (trivalent/pentavalent) is added into these pure semiconductors. This process is known as doping. It is then called an impurity or extrinsic semiconductor. The amount and type of impurities have to be closely controlled during the preparation of extrinsic semiconductor. Generally, for 10^8 atoms of semiconductor, one impurity atom is added.

Germanium and Silicon are two intrinsic semiconductors commonly doped to form extrinsic semiconductors.

(i) Germanium

Germanium has become the model substance among semiconductors; the main reason being that it can be purified relatively well and crystallized easily. Germanium is an earth element and was discovered in 1886. It is recovered from the ash of certain coals or from the flue dust of zinc smelters. Generally, recovered germanium is in the form of germanium dioxide powder which is then reduced to pure germanium. The atomic number of germaniums is 32. That is, it has 32 protons and 32 electrons. The electrons are arranged in the order 2,8,18,4 in the respective orbits. Therefore, it has 4 electrons in the valence orbit. It is a tetravalent element. The various germanium atoms are held together by covalent bonds. As atoms are arranged in an orderly manner, germanium has a crystalline structure.

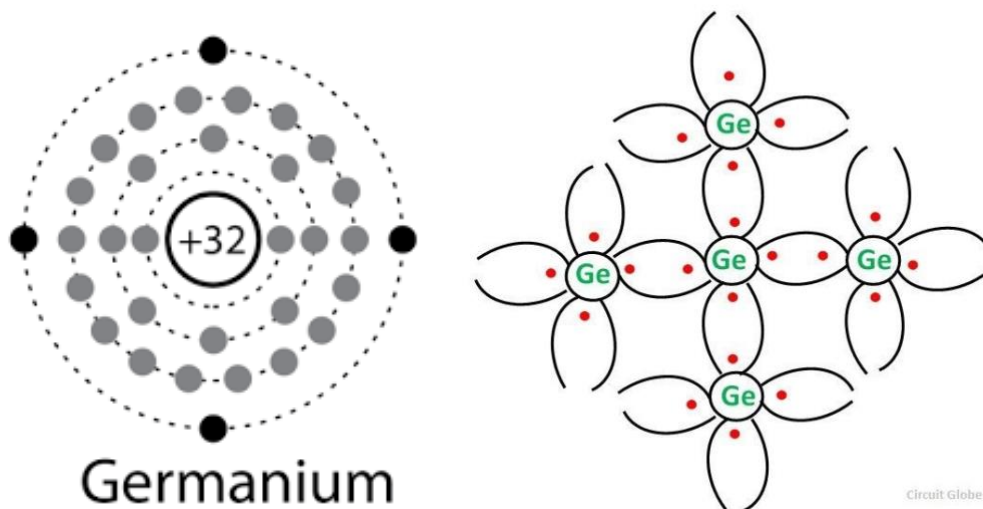

Fig 2.2 Electronic configuration and bonding of Ge atom

(ii) Silicon

Silicon is an element seen in most of the common rocks. The silicon compounds are chemically reduced to silicon dioxide which is 100% pure for use as a semiconductor. The atomic number of silicon is 14. That is, it consists of 14 protons and 14 electrons. The electrons are arranged in the order 2,8,4 in their respective orbits. It has 4 valence electrons in the valence orbit. That is, it is a tetravalent element. Various Si atoms are held together through covalent bonds. Like

germanium, silicon atoms are also arranged in an orderly manner. Therefore, it has a crystalline structure.

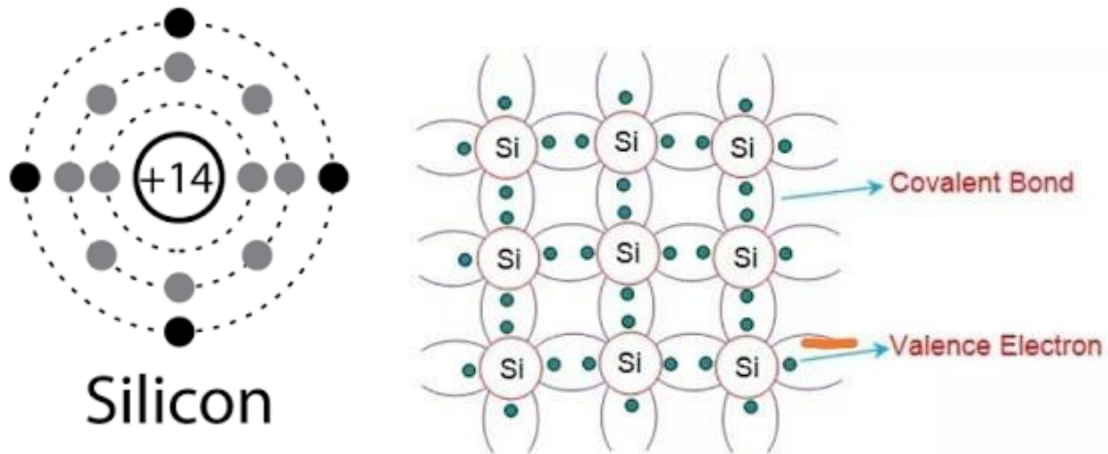

Fig 2.3 Electronic configuration and bonding of Si atom

There are two types of extrinsic semiconductors that can be formed by doping intrinsic semiconductors: n-type and p-type semiconductors, depending upon the impurities they are doped with.

2.4 n-type semiconductor and p-type semiconductor

(i) n-type semiconductor

When a small amount of pentavalent impurity is added to a pure semiconductor, it is known as n-type semiconductor. If a pentavalent impurity is added to the crystal, a large number of free electrons are produced in the semiconductor (e.g., arsenic, antimony). Since such impurities produce n-type semiconductors they are known as donor impurities because they donate free electrons to the semiconductor.

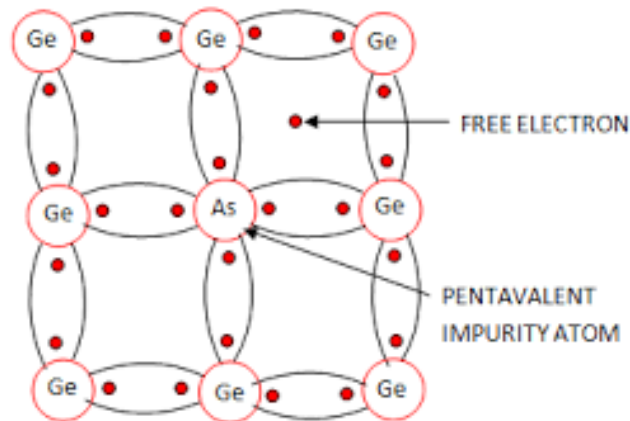

Fig 2.4 Arsenic doped Germanium

To explain the formation of N type semiconductor, consider a pure germanium crystal. We know that Germany matter has four valence electrons. When a small amount of pentavalent impurity like arsenic is added to germanium crystal, a large number of free electrons become available in the crystal. The reason is simple. Arsenic is pentavalent, that is, it has five valence electrons. An arsenic atom fits in the germanium crystal in such a way that its four valence electrons form covalent bonds with four germanium atoms. The 5th valence electron of arsenic atom finds no place in covalent bonds and is thus free. Therefore, for each arsenic atom added, one free electron will be available in germanium crystal. Though each arsenic atom provides one free electron, yet an extremely small amount of arsenic impurity provides enough atoms to supply millions of free electrons.

In an n type semiconductor, the 5th valence electron remains loosely bound to the nucleus. A small but definite amount of energy is required to detach this 5th electron from the nucleus and make it free. The energy required is small compared to the energy required for breaking a covalent bond and is easily provided by thermal agitation. The energy level corresponding to the fifth electron lies in the band gap just below the conduction bands and is called donor level. The depth of this level below the band is 0.01 eV for germanium and 0.03 for silicon. The electrons are easily transferred to the conduction band leaving behind positively charged immobile impurity ions.

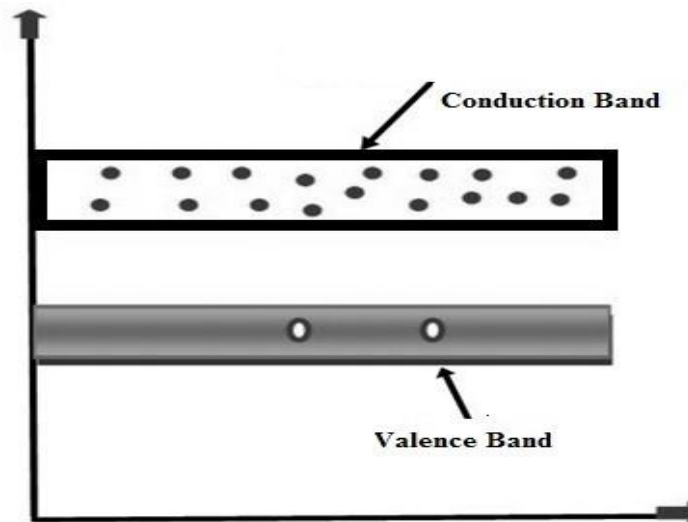

Fig 2.5 Valance band and conduction band of n-type semiconductor

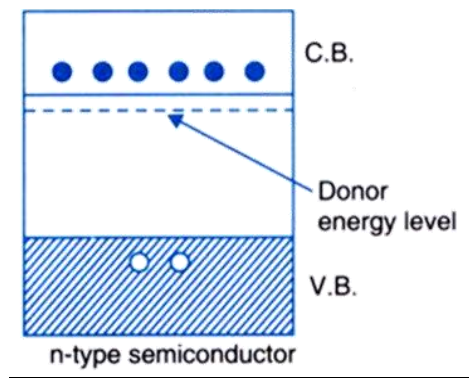

Fig 2.6 Donor level of n-type semiconductor

(ii) p-type semiconductor

When a small amount of trivalent impurity is added to a pure semiconductor, it is called P type semiconductor. The addition of trivalent impurity provides a large number of holes in the semiconductor. An example of a trivalent impurity are gallium and Indium. Such impurities which produce P type semiconductors are known as acceptor impurities because the holes created can accept the electrons.

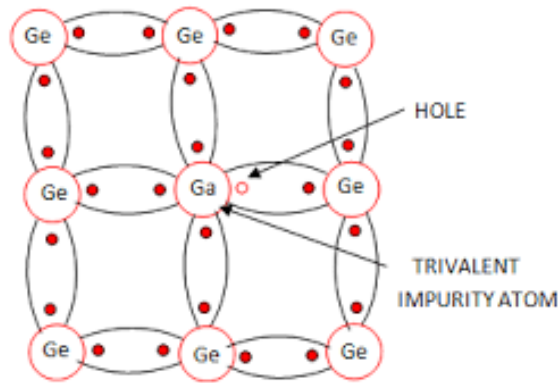

Fig 2.7 Gallium doped Germanium

When a small amount of trivalent impurity like gallium is added to germanium crystal, there exists a large number of holes in the crystal. Because gallium is a trivalent impurity it has three valence electrons. Each atom of gallium fits into the germanium crystal but now only three covalent bonds can be formed. It is because three valence electrons of gallium atom can form only three single covalent bonds with three germanium atoms. In the fourth covalent bond, only germanium atom contributes 1 valence electron while gallium has no valence electron to contribute as all its three valence electrons are already engaged in the covalent bonds with neighbouring germanium atoms. Therefore the 4th bond is incomplete; being short of 1 electron. This missing electron is called a hole. For each gallium atom added one hole is created. A small amount of gallium provides millions of holes. There are a few conduction band electrons due to thermal energy associated with room temperature. But the holes far outnumber the conduction band electrons. It is due to the predominance of holes over the free electrons that it is called a P type semiconductor.

In p type semiconductor, the trivalent impurity atom has a tendency to accept one electron to complete the 4th covalent bond. This process requires a small amount of energy which is provided by the thermal agitation in the crystal. The transferred electron leaves behind a broken covalent bond, a hole- which acts as a current carrier. The energy level corresponding to the electron deficiency is located above the valence band and it's called the acceptor level. This level is located at 0.01 eV above the valence band in germanium and about 0.046 to 0.16 eV in silicon. An electron can be easily transferred from the valence band to the acceptor level by providing this small energy.

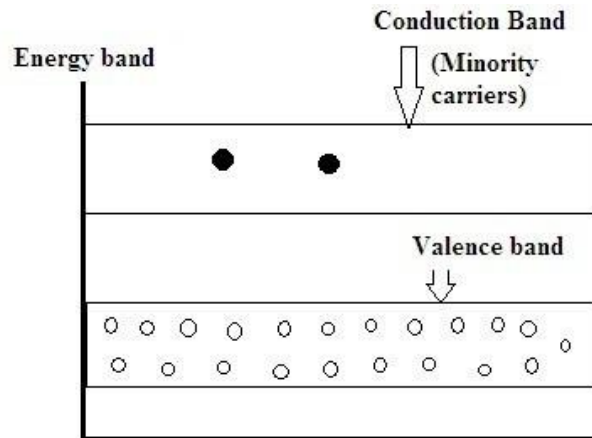

Fig 2.8 Valance band and conduction band of p-type semiconductor

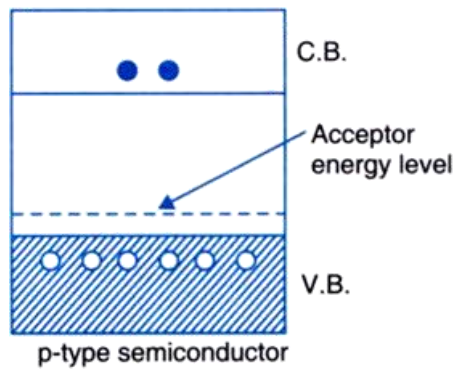
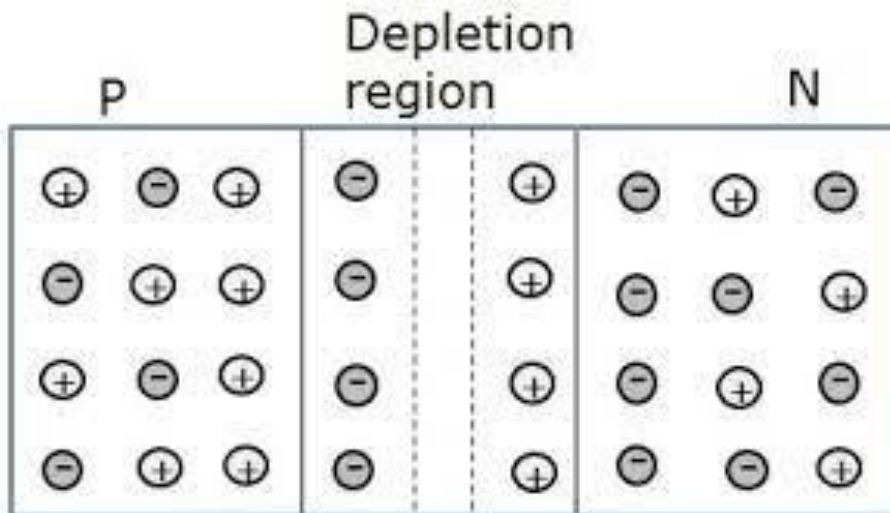

Fig 2.9 Acceptor level of p-type semiconductor

A p-type and n-type semiconductors joins together to form a p-n junction.

2.5 PN Junction and its properties

A PN junction is formed when a p-type semiconductor and n-type semiconductor are joined together. The surface of contact between the semiconductors is known as the PN junction. The PN junction has the peculiar ability to permit the current flow in one direction.



2.10 p-n junction

In the p region, holes are the majority carriers and in the n region, electrons are the majority carriers. Due to this concentration gradient, holes from p region diffuse into n region and electrons from n region diffuse into p region. In both cases, when an electron meets a hole, the two cancel the effect of each other. As a result, the n region loses free electrons, and the p region loses holes as they diffuse into the junction. This creates a layer of negative charges and positive charges near the junction forming a region of devoid or emptied charge carriers called the depletion region or depletion layer. The depletion region is very thin as compared to the p region and n region and it forms very quickly. The thickness of the depletion layer is 10^{-6} m.

Due to the diffusion of holes and electrons, the two sections of the PN junction no longer remain neutral. The p section of the junction becomes slightly negative while the n section is rendered positive. The potential difference developed across the junction due to the migration of majority charge carriers is called the barrier potential, V_0 . The depletion region acts as a barrier to further movement of free electrons across the depletion layer. The type of semi conducting material, the amount of doping and temperature are some of the factors that barrier potential depends upon. The barrier potential is approximately 0.7V for silicon and 0.3 V for germanium.

2.6 Forward biasing and Reverse biasing of a p-n junction

Biasing is the process of using DC voltage to establish certain operating conditions for electronic devices. There are two types of biasing with respect to the PN junction:

FORWARD BIAS

If the positive terminal is connected to the p section and negative terminal is connected to the n section of the battery the PN junction is said to be forward biased. In this condition, the applied voltage opposes the potential barrier. The holes are repelled from the positive terminal and the electrons are repelled from the negative terminal and they move towards the junction. The applied voltage V cancels the barrier potential V_0 and under the influence of the electric field of the battery, the holes and the electrons penetrate the depletion layer. Consequently, the potential barrier and the width of the depletion region decreases, and more majority carriers diffuse across the junction.

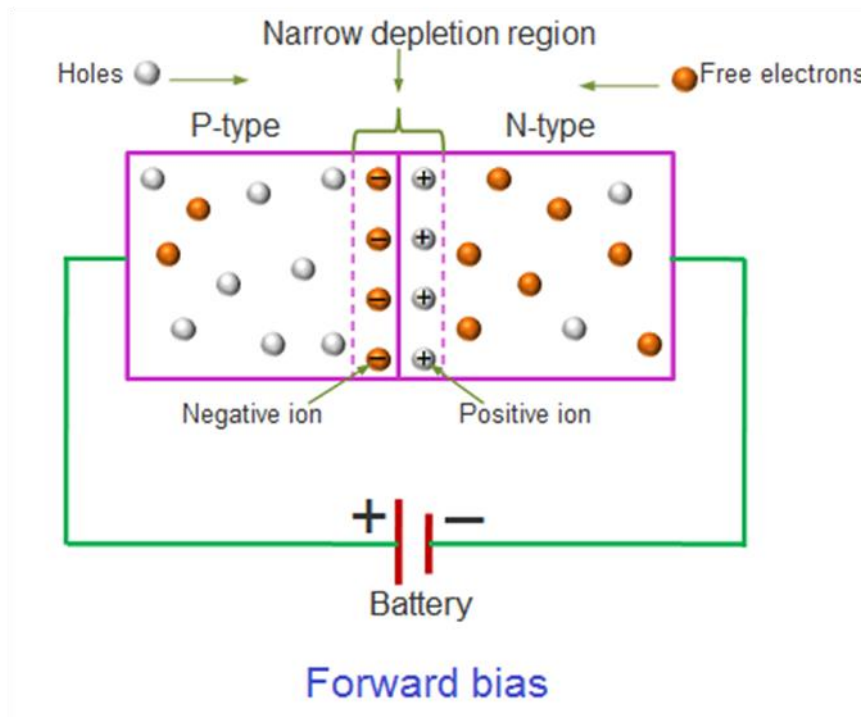

2.11 Forward biased p-n junction

The movement of electrons towards the positive terminal and holes towards the negative terminal produces a high forward current. This forward current increases with the increase in applied voltage. Forward PN junction offers a low resistance.

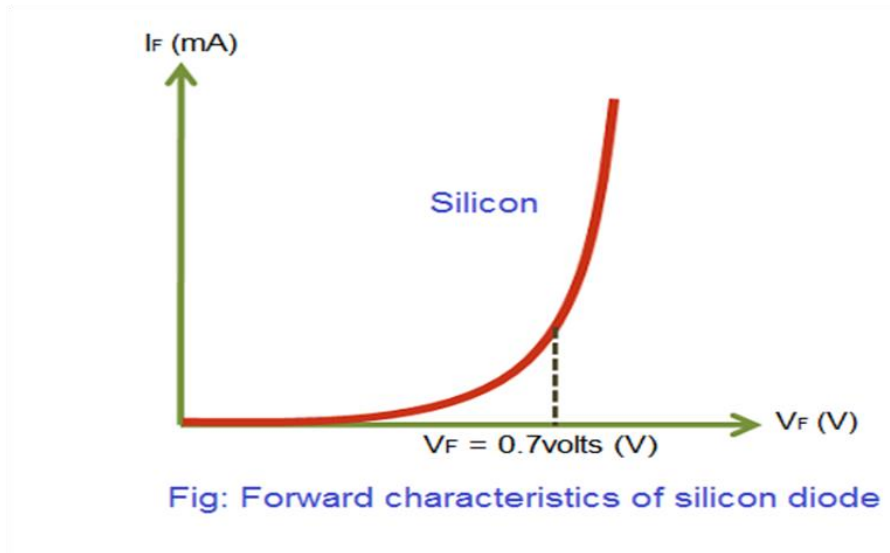

Fig 2.12 Forward characteristics of p-n junction diode

The graph shows the variation of forward voltage and forward current. The increase in current is slow till the voltage across the diode crosses a value called knee voltage. Knee voltage for germanium is 0.3V and for silicon is 0.7V. After the knee voltage the diode current increases rapidly even for small rise in voltage.

REVERSE BIAS

If the PN junction of the diode is connected to the negative terminal of the battery and n region to the positive terminal of the battery, the PN junction is said to be reverse biased. The holes in the p region are attracted towards the negative terminal of the battery and the electrons in the n region are attracted to the positive terminal of the battery. The applied reverse voltage acts in the same direction as the potential barrier V_0 , therefore the resultant field at the junction increases. The potential barrier prevents the flow of charge carriers across the junction.

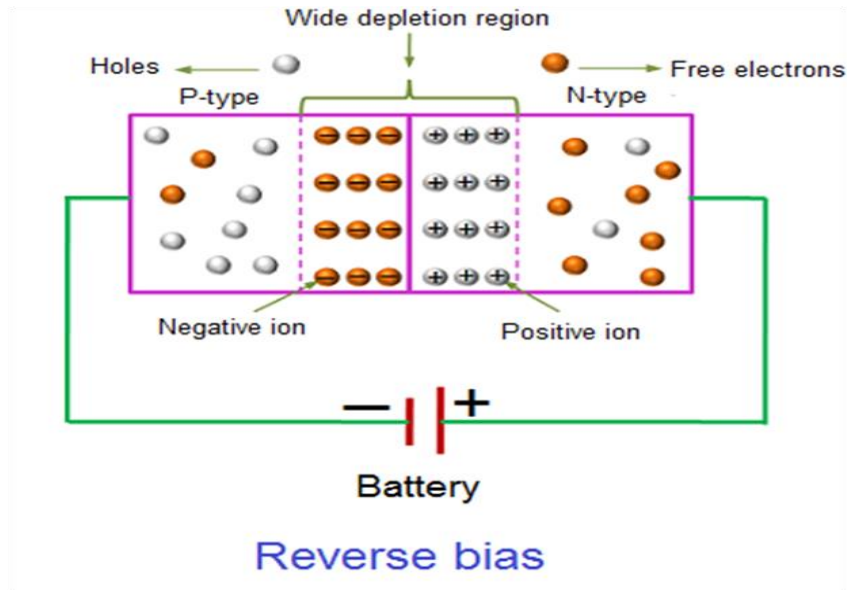

Fig 2.13 Reverse biased p-n junction

Minority charge carriers are the intrinsically available carriers that are produced by thermal energy that exists inside the semiconductors. The electrons are the minority carriers in the p region and holes are the minority carriers in the n region. The minority carriers when reverse biases are effectively forward biased, causing a feeble current of few microamperes across the junction.

Graph shows the variation of reverse voltage and reverse current.

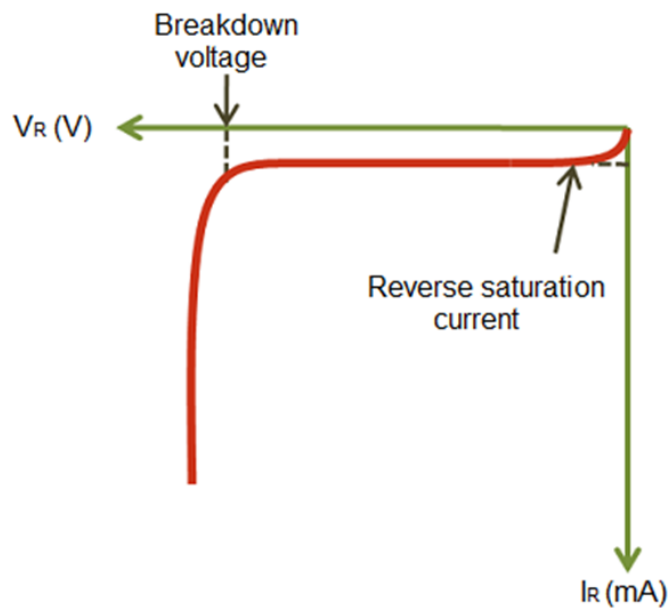

Fig: Reverse characteristics of diode

Fig 2.14 Reverse characteristics of p-n junction diode

2.7 Effect of temperature on semiconductors

The variations of temperature affect the electrical conductivity of semiconductors appreciably.

i) At absolute zero: at zero absolute temperature, the electrons are held tightly by the semiconductor atoms. The inner orbit electrons are bound to the nucleus and the valence electrons are bound by covalent bonding. At this temperature, there will be no free electrons due to the strong covalent bonds. Hence, the semiconductor acts like an insulator.

With respect to the energy band description, the valence band is filled and there is a large gap between valence band and conduction band. Therefore, no free electrons are formed since no valence electrons reach the conduction band. Non-availability of free electrons makes a semiconductor behave like an insulator.

ii) Above absolute zero: when temperature increases even at room temperature, some of the covalent bonds break due to thermal energy supplied. The electrons, which were engaged in covalent bonds become free. Thus, due to the presence of the free electrons a feeble electric current is produced if a potential difference is applied across the semiconductor. Hence the resistance of a semiconductor decreases with the increase in temperature i.e., it has a negative temperature coefficient of resistance.

As temperature increases some of the valence electrons gain sufficient energy to enter into conduction band and thus become free electrons. When electric field is applied, these free electrons will constitute electric current. Each time a valence electron enters into conduction band, a hole is created in the valence band. Holes also contribute to current.

2.8 Fermi level and Fermi energy

The highest energy level that an electron can occupy at absolute zero temperature is known as Fermi level. The Fermi level lies in the middle of the conduction and valence band.

The concentration of donors or acceptors affects the Fermi energy area concentration and the conductivity of a semiconductor. All the donors are in the unionized state, that is all the donor levels are occupied with electrons at 0 Kelvin in an n type semiconductor. As temperature increases, what is donors get ionized and contribute electrons to the conduction band also some of the valence electrons jump to the conduction band leaving behind holes in the valence band

which are quite small. Therefore, the Fermi level must lie somewhere near the middle of the donor level and the bottom of the conduction band.

The Fermi level lies somewhere near the middle of the donor level and the conduction band edge as temperature increases, the Fermi level moves downwards and crosses the donor level. For very large temperature, it drops to the middle of the energy gap, coinciding with the intrinsic level.

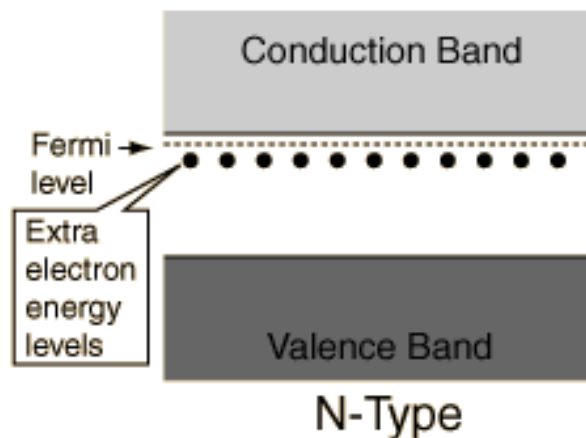

Fig 2.15 Fermi level of n-type semiconductor

In p type semiconductor the acceptor impurity atoms occupy the acceptor levels which lie above the valence band. As temperature increases a part of the acceptors get ionized by acquiring electrons from the valence band and create holes in the valence band. Apart from this, some thermally generated holes are also present in the valence band. Therefore, the Fermi level must lie somewhere near the middle of the acceptor level and the top of the valence band.

The Fermi level lies somewhere near the middle of the acceptor level and the top of the valence band. As temperature increases, the Fermi level moves even upwards and coincides with the intrinsic level.

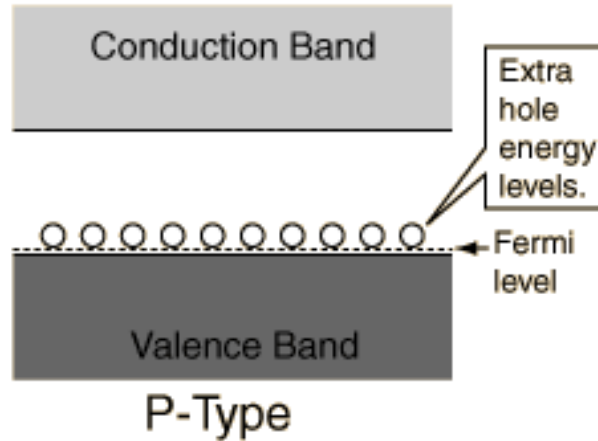

Fig 2.16 Fermi level of p-type semiconductor

2.9 Energy Band description of Semiconductors

In terms of resistivity, a semiconductor is a substance whose resistivity lies between conductors and insulators (10^{-4} ohm meter to 0.5 ohm meter).

Based on energy band gaps, the semiconductors can be inclusively defined as " a semiconductor is a substance with almost filled valence band and nearly empty conduction band with a very small energy gap (approximately 1 eV) separating the two.

In the energy band diagrams of silicon and germanium, it can be noted that the energy gap is very small, 1.1 eV for silicon and 0.72 eV for germanium. Since the energy gap is too small, the valence electrons can cross over to the conduction band easily. Even room temperature would be sufficient for some electrons to enter the conduction band and become free electrons. However, at this temperature the availability of free electrons is very small. Therefore, a germanium or silicon piece at room temperature is neither a good conductor nor an insulator. Hence, they are known as semiconductors.

A semiconductor always possesses an energy gap between its valence band and conduction band. For the conduction of electricity, a certain amount of energy is given to the electron so that it can jump from the valence band to the conduction band. The energy so needed is the measure of the energy gap between the top of the valence band and bottom of the conduction band. For silicon, the energy gap is equal to 1.1 electron Volt.

To determine the energy band gap of a semiconducting material, we study the variation of its conductance with temperature. The bandgap energy of semiconductors tends to decrease with increasing temperature. In reverse bias, the current flowing through the PN junction is quite small and the internal heating of the junction does not take place. When the PN junction is placed in reverse bias the current flow through the junction is due to the minority charge carriers only. The concentration of these charge carriers depends on the band gap E_{G_0} .

Forward or reverse current of a diode depends upon temperature by relation,

$$I = I_0 \exp \left[\frac{eV}{\eta kT} - 1 \right]$$

At ordinary temperature, $\exp \left[\frac{eV}{\eta kT} - 1 \right] \gg 1$

Hence, 1 is neglected.

$$I = I_0 \exp \left[\frac{eV}{\eta kT} \right]$$

Taking logarithm, we get

$$\ln(I) = \ln I_0 + \frac{eV}{\eta kT}$$

Differentiating with respect to T for a given fixed current I,

$$0 = \frac{1}{I_0} \frac{dI_0}{dT} + \frac{1}{\eta kT} \frac{dV}{dT} - \frac{V}{\eta V_T T}$$

$$V - \frac{\eta V_T T}{I_0} \frac{dI_0}{dT} = T \frac{dV}{dT}$$

The empirical relation connecting reverse saturation current and leakage current is given by,

$$I_0 = K T^m \exp \left(-\frac{eV_0}{\eta kT} \right)$$

Taking logarithm,

$$\ln I_0 = \ln K + m \ln T - \left(\frac{eV_0}{\eta kT} \right)$$

Where V_0 = Band gap energy

Differentiating with respect to T,

$$\frac{1}{I_0} \frac{dI_0}{dT} = 0 + \frac{m}{T} + \frac{eV_0}{\eta KT^2}$$

$$\begin{aligned} \frac{I}{I_0} \frac{dI_0}{dT} &= m + \frac{eV_0}{\eta KT} \\ &= m + \frac{V_0}{\eta V_T} \end{aligned}$$

Substituting this in equation, $V - \frac{\eta V_T T}{I_0} \frac{dI_0}{dT} = T \frac{dV}{dT}$

We get,

$$\begin{aligned} T \frac{dV}{dT} &= V - \eta V_T \left(m + \frac{V_0}{\eta V_T} \right) \\ &= V - \eta m V_T - V_0 \end{aligned}$$

$$V_T = \frac{KT}{e} = \frac{T}{11600}$$

$$V_0 = V - \eta m V_T - T \frac{dV}{dT}$$

$$V_0 = V - \frac{\eta m KT}{e} - T \frac{dV}{dT}$$

$$V_{G_0} = V - T \left[-\frac{dV}{dT} + \frac{\eta m K}{e} \right]$$

CHAPTER 3

3.1 EXPERIMENTAL SET UP AND PROCEDURE TO DETERMINE THE BAND GAP ENERGY OF Ge AND Si DIODE

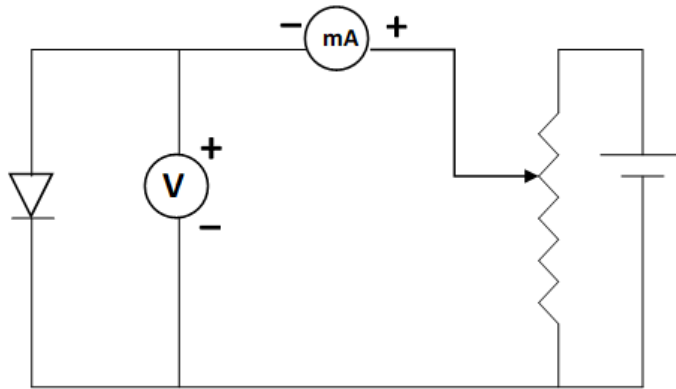

Fig 3.1 Circuit diagram of the experimental set up

Connections are made as shown in the figure. The variable resistance was adjusted so that particular current flows through diode. The semiconductor diode was immersed in an oil bath in a test tube. The voltage across diode was noted using multimeter at room temperature. The diode in the test tube was placed in medium water bath (water in a beaker) to heat the test tube and voltage across diode was noted for various values of temperatures.

A graph was plotted with temperature along X axis and voltage along Y axis. The slope $\frac{dV}{dT}$ is calculated. Knowing $\frac{dV}{dT}$ at a particular temperature and corresponding voltage bandgap energy can be calculated as V_{G_0} .

$$V_{G_0} = V - T \left[-\frac{dV}{dT} + \frac{\eta mK}{e} \right]$$

3.2 OBSERVATION AND RESULT ANALYSIS

GERMANIUM

Voltage of the cell = 6V

Temperature (kelvin)	Voltage of voltmeter (V)			
	I = 1mA	I = 3mA	I = 5mA	I = 7 mA
303	0.172	0.215	0.232	0.253
313	0.153	0.196	0.218	0.234
323	0.135	0.179	0.195	0.217
333	0.114	0.160	0.176	0.197
343	0.098	0.141	0.158	0.178
353	0.080	0.115	0.139	0.157
363	0.064	0.104	0.123	0.142

Graph and graphical observations

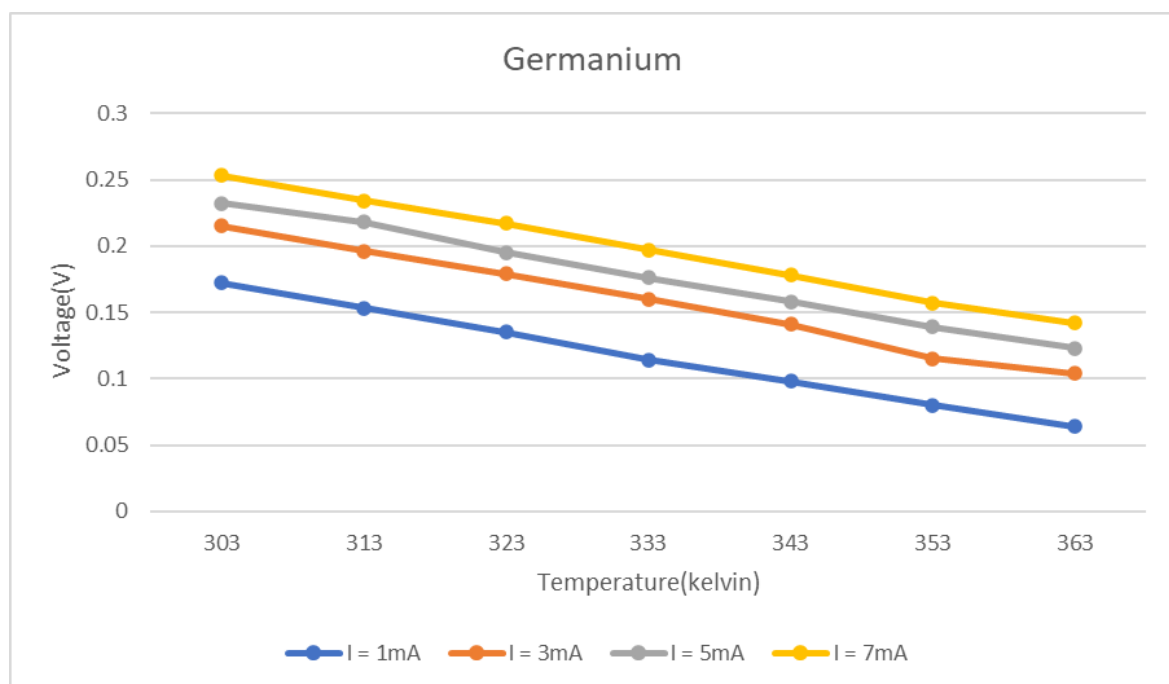

Fig 3.2 Temperature vs Voltage graph of Germanium diode

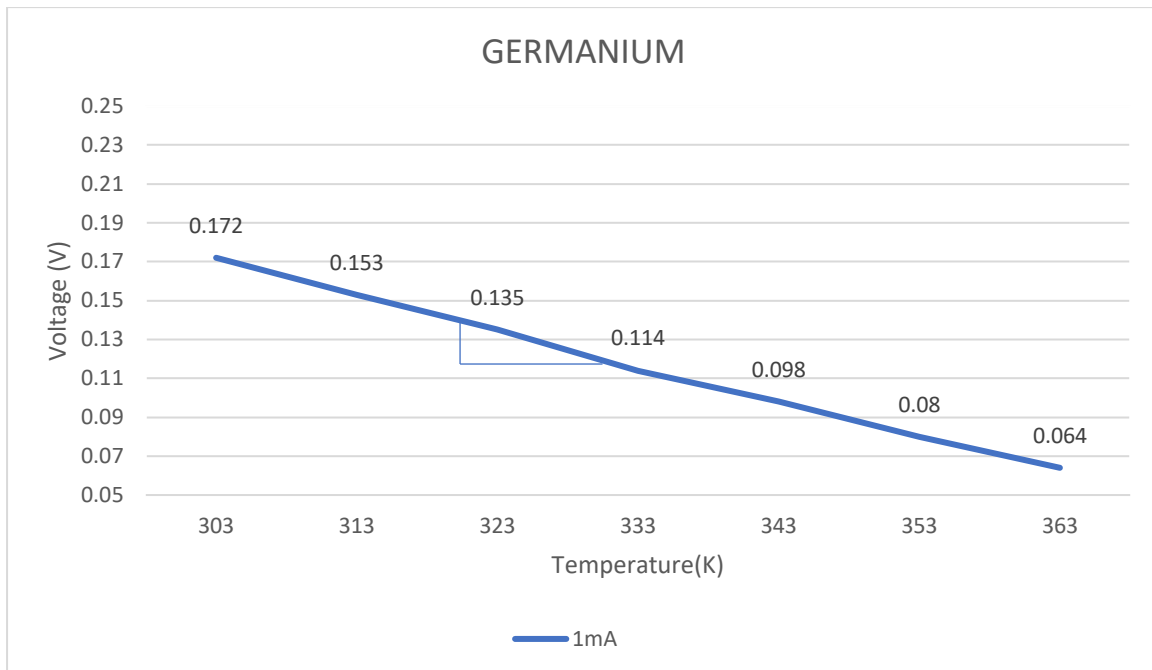

Fig 3.3 Slope of Temperature vs Voltage graph of Germanium for 1mA

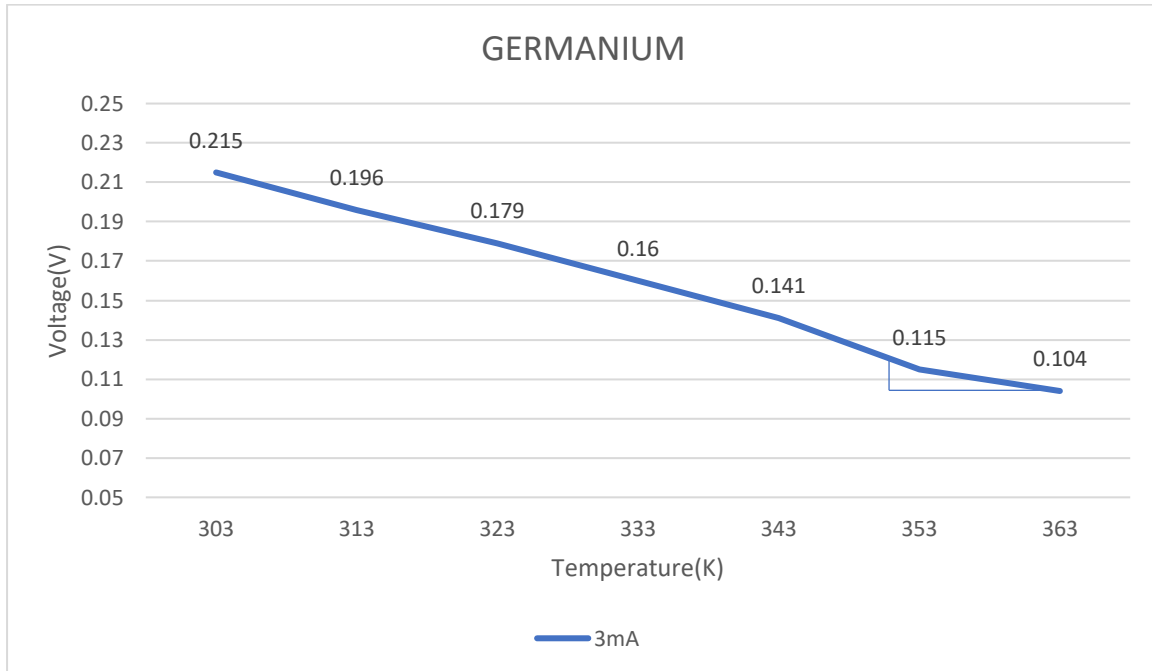

Fig 3.4 Slope of Temperature vs Voltage graph of Germanium for 3mA

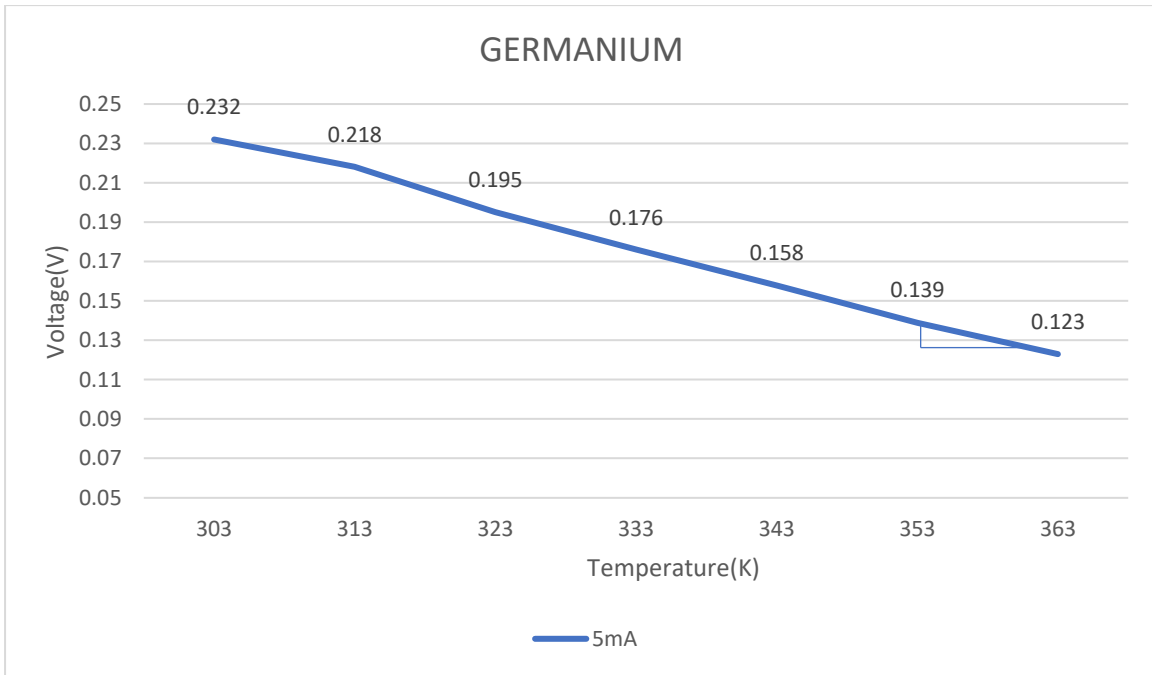

Fig 3.5 Slope of Temperature vs Voltage graph of Germanium for 5mA

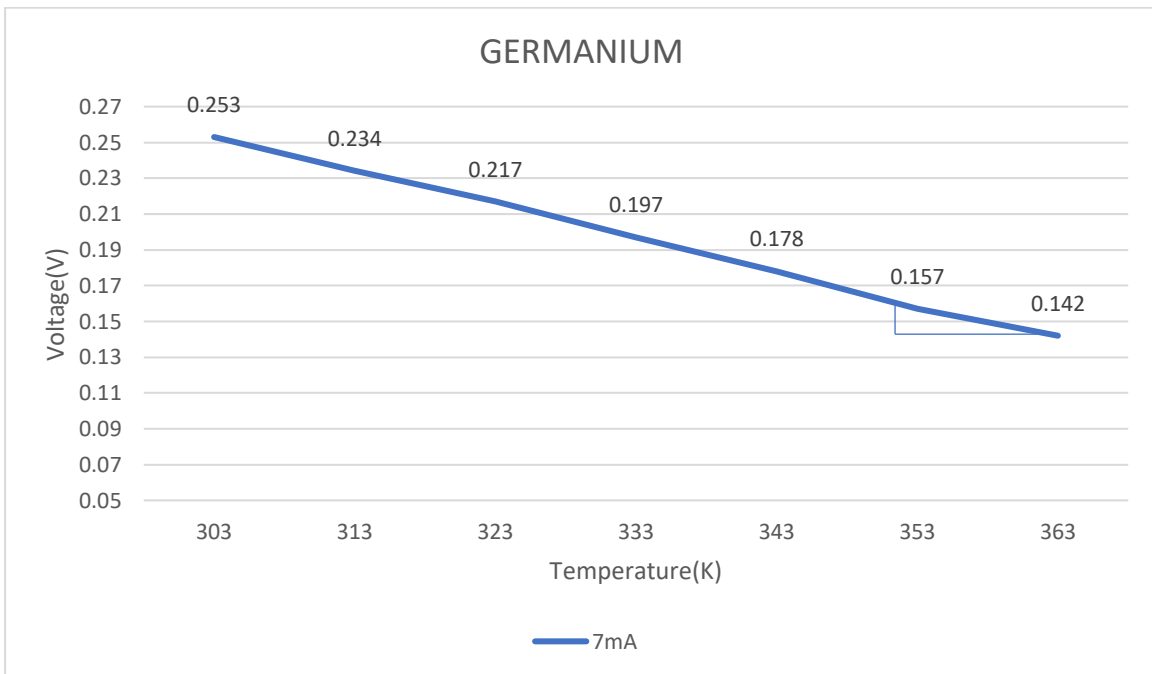

Fig 3.6 Slope of Temperature vs Voltage graph of Germanium for 7mA

Current (mA)	Voltage (v)	Temperature (kelvin)	dV (V)	dT (K)	$-\frac{dV}{dT}$ (V/K)	Band Gap Energy, E_{G_0} (eV)
1	0.1255	328	0.019	10	-1.9×10^{-3}	0.7062
3	0.113	358	0.018	10	-1.8×10^{-3}	0.7110
5	0.132	357	0.014	8	-1.75×10^{-3}	0.7105
7	0.152	357	0.014	8	-1.75×10^{-3}	0.7305

SUBSTITUTION & CALCULATIONS

$$I = 1\text{mA}$$

$$V = \frac{0.135+0.116}{2} = 0.1255 \text{ V}$$

$$T = \frac{333+323}{2} = 328 \text{ K}$$

$$\frac{-dV}{dT} = \frac{-(0.135-0.116)}{333-323} = \frac{-0.019}{10} = -1.9 \times 10^{-3} \text{ V/K}$$

$$\frac{\eta m K}{e} = \frac{1 \times 1.5 \times 1.38 \times 10^{-23}}{1.6 \times 10^{-19}} = 1.29375 \times 10^{-4}$$

$$V_{G_0} = V - T \left[-\frac{dV}{dT} + \frac{\eta m K}{e} \right]$$

$$V_{G_0} = 0.1255 - 328[-1.9 \times 10^{-3} + 1.29375 \times 10^{-4}]$$

$$= 0.7062 \text{ eV}$$

$$\text{Mean energy gap} = 0.71 \text{ eV}$$

$$\text{Percentage of error} = \left| \frac{0.72-0.71}{0.72} \right| \times 100 = 1.38\%$$

SILICON

Voltage of the cell = 6V

Temperature (kelvin)	Voltage of voltmeter (V)			
	I = 1mA	I = 3mA	I = 5mA	I = 7 mA
303	0.568	0.630	0.658	0.676
313	0.548	0.606	0.636	0.656
323	0.529	0.586	0.616	0.640
333	0.509	0.562	0.594	0.614
343	0.494	0.548	0.569	0.594
353	0.466	0.524	0.552	0.572
363	0.457	0.504	0.536	0.550

Graph and graphical observations

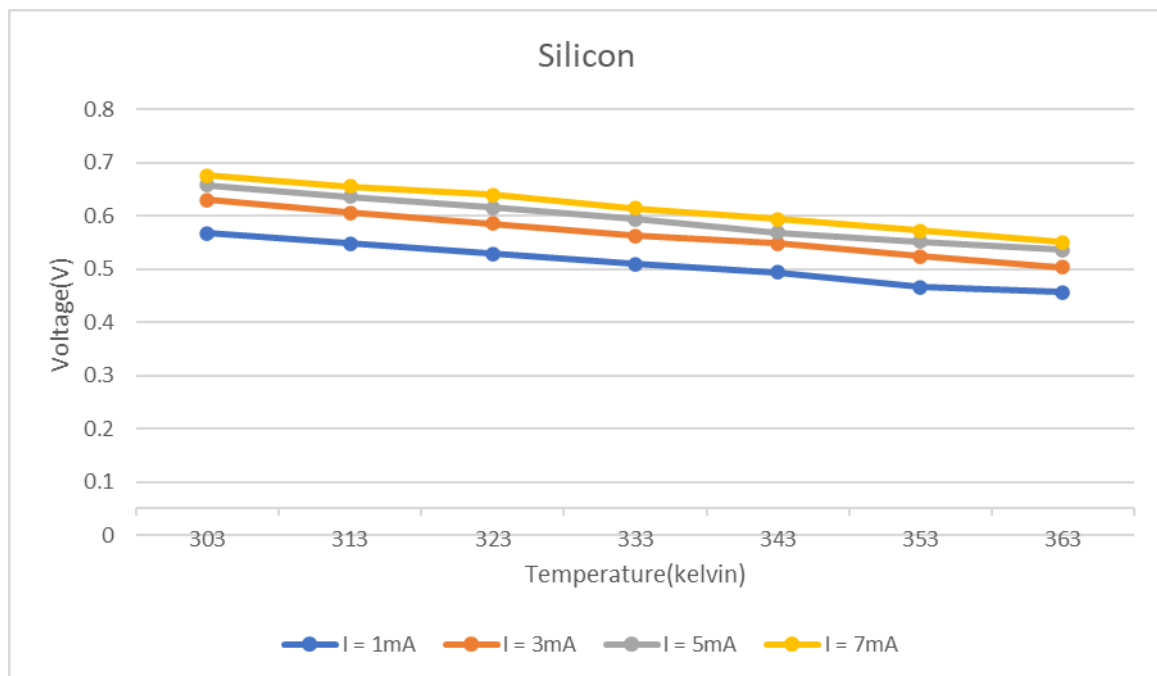

Fig 3.7 Temperature vs Voltage graph of Silicon diode

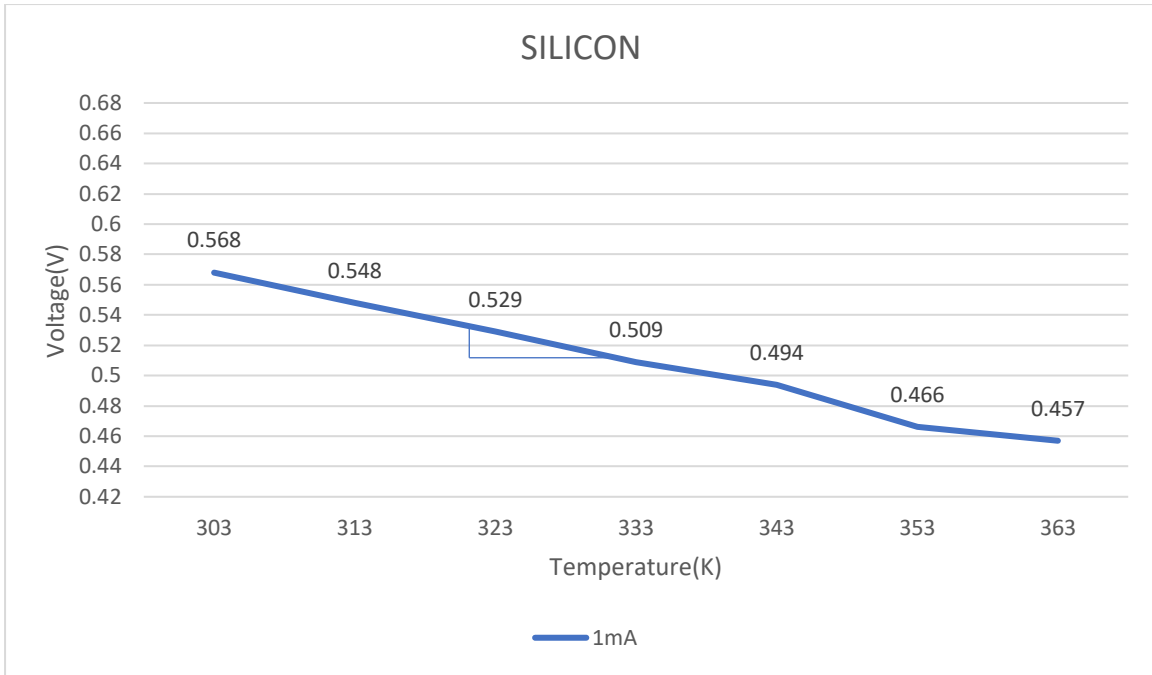

Fig 3.8 Slope of Temperature vs Voltage graph of Silicon for 1mA

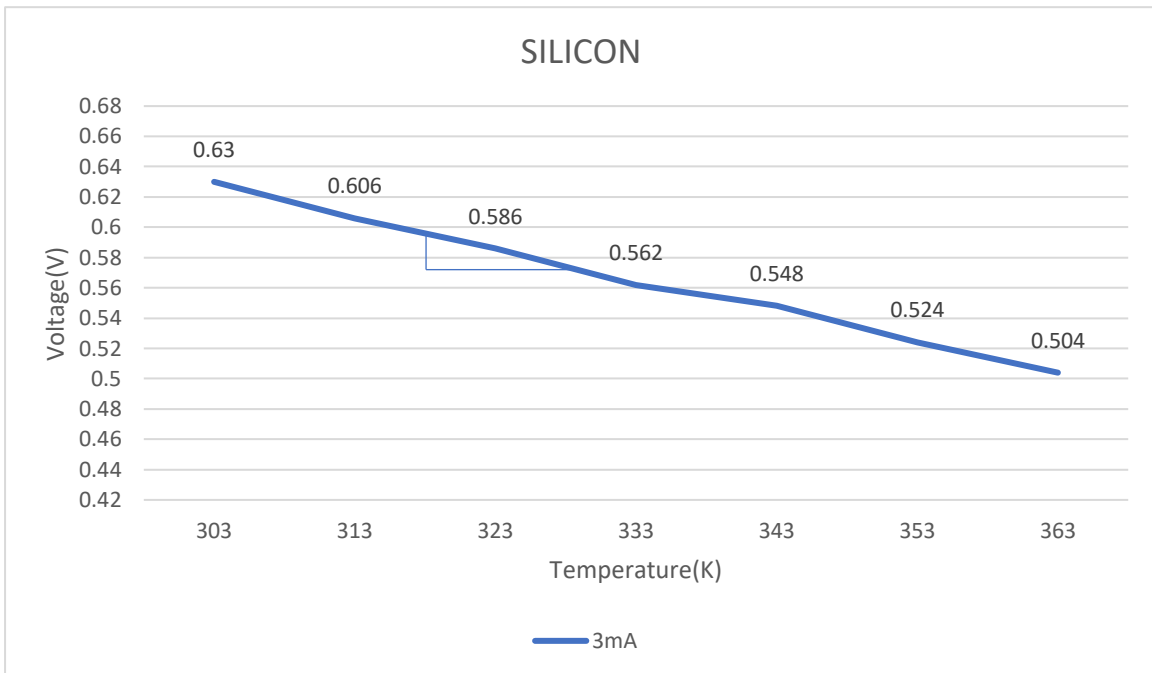

Fig 3.9 Slope of Temperature vs Voltage graph of Silicon for 3mA

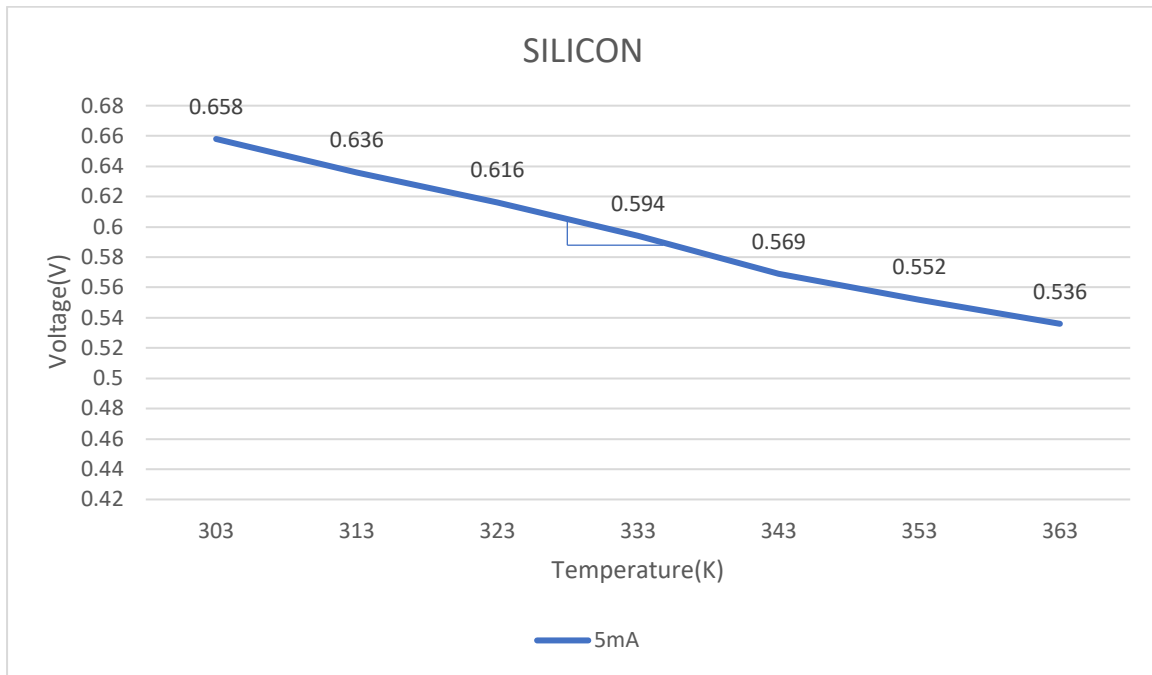

Fig 3.10 Slope of Temperature vs Voltage graph of Silicon for 5mA

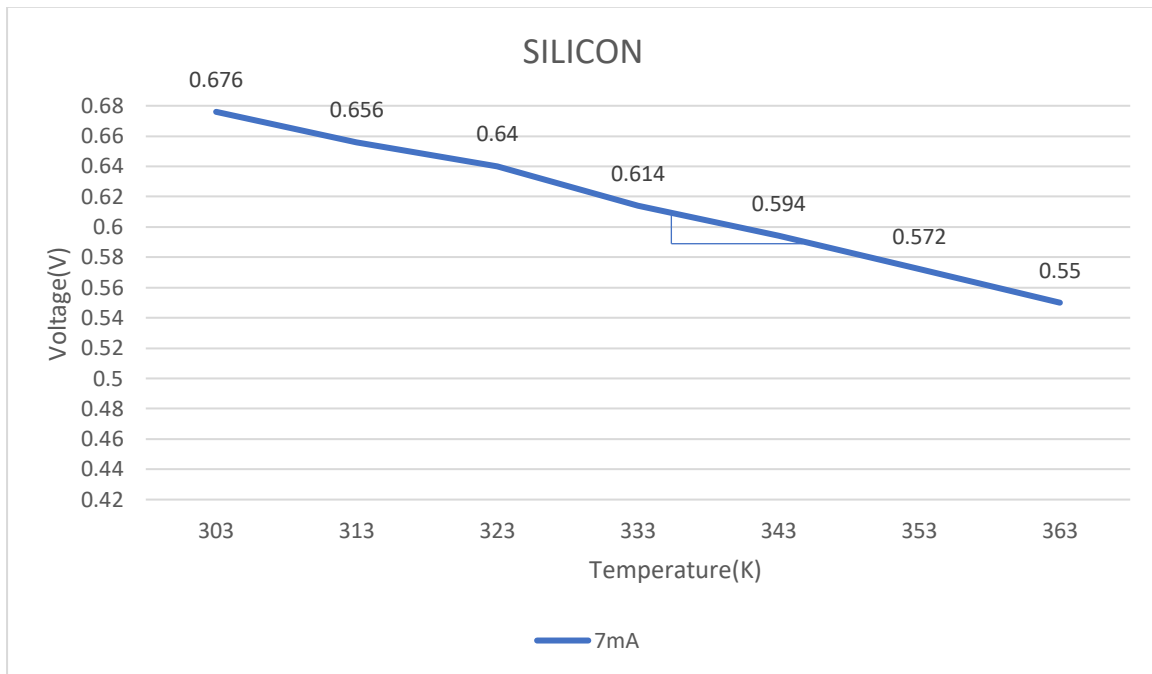

Fig 3.11 Slope of Temperature vs Voltage graph of Silicon for 7mA

Current (mA)	Voltage (v)	Temperature (kelvin)	dV (V)	dT (K)	$-\frac{dV}{dT}$ (V/K)	Band Gap Energy, E_{G_0} (eV)
1	0.52	326.5	0.02	9	-2.22×10^{-3}	1.160
3	0.583	324.5	0.026	13	-2×10^{-3}	1.148
5	0.597	331.5	0.014	7	-2×10^{-3}	1.174
7	0.5995	340	0.019	8	-2.37×10^{-3}	1.131

SUBSTITUTION & CALCULATIONS

$$I = 7 \text{ mA}$$

$$V = \frac{0.609 + 0.59}{2} = 0.5995 \text{ V}$$

$$T = \frac{336 + 345}{2} = 340 \text{ K}$$

$$-\frac{dV}{dT} = \frac{-(0.609 - 0.59)}{345 - 336} = \left(-\frac{0.019}{8}\right) = -2.375 \times 10^{-3} \text{ V/K}$$

$$\frac{\eta m K}{e} = \frac{2 \times 1.5 \times 1.38 \times 10^{-23}}{1.6 \times 10^{-19}} = 2.5875 \times 10^{-4}$$

$$V_{G_0} = V - T \left[-\frac{dV}{dT} + \frac{\eta m K}{e} \right]$$

$$\begin{aligned} V_{G_0} &= 0.5995 - 340 \left[-2.375 \times 10^{-3} + 2.5875 \times 10^{-4} \right] \\ &= 1.131 \text{ eV} \end{aligned}$$

$$\text{Mean energy gap} = 1.153 \text{ eV}$$

$$\text{Percentage of error} = \left| \frac{1.14 - 1.153}{1.14} \right| \times 100 = 1.140\%$$

The experiment to determine the band energy gap of silicon and germanium diodes was conducted successfully.

Band energy gap of silicon=1.153eV

Band energy gap of germanium= 0.71eV

The results were found to be nearer to the standard values which are 0.72 eV and 1.14 eV for silicon and germanium respectively.

CHAPTER 4

4.1 Applications of Ge and Si diodes

Germanium diodes can be used for photonic applications.

Essentially all data transmission that occurs over long distances (think all internet usage) occurs over optical fibres. Optical fibres are essentially transparent glass fibres, through which light can be transmitted. In order to be able to transmit data over long distance, we have chosen to use light in the near infrared part of the spectrum. This is because this part of the spectrum experiences the lowest losses while traveling in glass.

Germanium has the property such that the bandgap energy is approximately equal to the energy of photons in the near infrared. This means that if you shine light of this wavelength onto a germanium diode, you can excite electrons, and produce a current. Therefore, we use germanium diodes as photodetectors to detect near-infrared light for telecommunication applications.

In addition, a light emitter and a light detector are very similar devices. Therefore, we can make lasers out of germanium diodes that are capable of producing this near infrared light that can be used to send data over long distances.

One final application is in solar cells. Solar cells can be very efficient at absorbing light and creating electricity, but only at a limited range of wavelengths. In order to make the most efficient solar cells possible, people usually stack many solar cells on top of each other. You can think of having one solar cell for UV light, one for visible light, and one for infrared (IR) light. Germanium diodes are used as the solar cells responsible for absorbing the IR light and converting it into electricity.

The silicon rectifier diodes are often utilized in **radios, computers, alternating current-direct current (AC/DC) power supplies, and as temperature and radiation sensors**, within numerous other applications.

REFERENCE

- [1] "Semiconductor nanowires for energy conversion," P. Yang, 2010.
- [2] "Semiconductor Physics and Semiconductor Devices," T. Inoguchi, J. Inst. Telev. Eng. Japan, 1974.
- [3] Physics of Semiconductor Devices, M. Rudan, 2015.
- [4] "A Review on Semiconductors Including Applications and Temperature Effects in Semiconductors," M. A. Rahman, Am. Sci. Res. J. Eng. Technol. Sci., ISSN, 2014.
- [5] "Types of Solar Cells and Application," A. Mohammad Bagher, Am. J. Opt. Photonics, 2015.
- [6]"Organic semiconductor crystals," C. Wang, H. Dong, L. Jiang, and W. Hu, Chemical Society Reviews, 2018.
- [7]"Ultrawide-Bandgap Semiconductors: Research Opportunities and Challenges," J. Y. Tsao et al., Advanced Electronic Materials, 2018.
- [8] "Doping of organic semiconductors," B. Lüssem, M. Riede, and K. Leo, Physica Status Solidi (A) Applications and Materials Science. 2013.
- [9] "Roadmap on semiconductor-cell biointerfaces," Physical Biology, B. Tian et al., 2018.
- [10] "Fundamentals of Semiconductors," in Green Energy and Technology, T. Kita, Y. Harada, and S. Asahi,2011.
- [11] Principles of Electronics, V K Mehta, Rohit Mehta, 11e, S Chand, Chapter 5, Chapter 6.
- [12] IIT Kharagpur, Virtual Labs, 'Applications of Germanium and Silicon diodes'
- [13] <https://www.gdrectifiers.co.uk> , 'Introduction to Silicon rectifier diodes'
- [14] Britannica Encyclopaedia, Frank Neville H. Robinson, Eustace E. Suckling, Edwin Kashy, 'Conductors, Insulators and Semiconductors'.
- Frank Neville H. Robinson, Eustace E. Suckling, Edwin Kashy